

TILVALIN GEYMSLA FYRIR GRILLIÐ OG GARÐHÚSGÖGNIN

Einbýlishús

Sumarhús

Parhús

Raðhús

Garðhúsi

Garðhúsin eru til í mismunandi útfærslum og stærðum; ýmist með einfaldri hurð eða tvöfaldrí, með eða án glugga eða með eða án gólfs. Spurningin er bara hvað hentar hverjum.

Garðhúsin eru tilvalin geymsla fyrir grillið, garðhúsgögnin, garðverkfæin, sláttuvélina eða jafnvel sem vinnustöð fyrir garðverkin. Svo er auðvitað alltaf hægt að setjast á stól í garðhúsinu og tálga einn og einn karl úr víði sem fellur til í garðinum.

Garðhúsin okkar eru bjálkahús sem eru frá 34 mm að þykkt og með tvöfaldrí vatnslæsingu eða nótun.

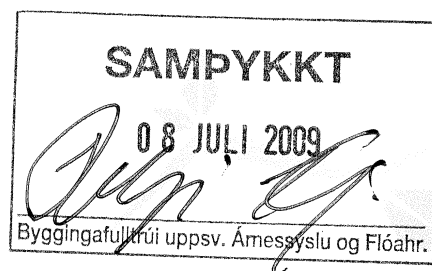

Garðhús 4,7 m²

Stærð	Bjálkabykk	Lengd (mm)	Breidd (mm)
4,7 m ²	34 mm	2000	2500

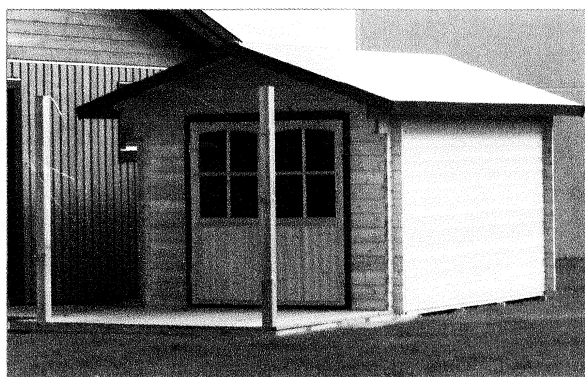

Garðhús 6 - 9,7 m²

	Stærð	Bjálkabykk	Lengd (mm)	Breidd (mm)
A	6,0 m ²	34 mm	2435	2535
B	7,2 m ²	34 mm	2935	2535
C	8,5 m ²	34 mm	3435	2535
D	9,7 m ²	34 mm	3935	2535

— 226

5 x 120 x 70
þyngd. 900 kg

völundarhús.is
Vel valið fyrir húsið þitt

1680x1840 - 1 set



BOARD ...x65x1760 FOR SETTLEMENT
SLOT FROM BOTH SIDES

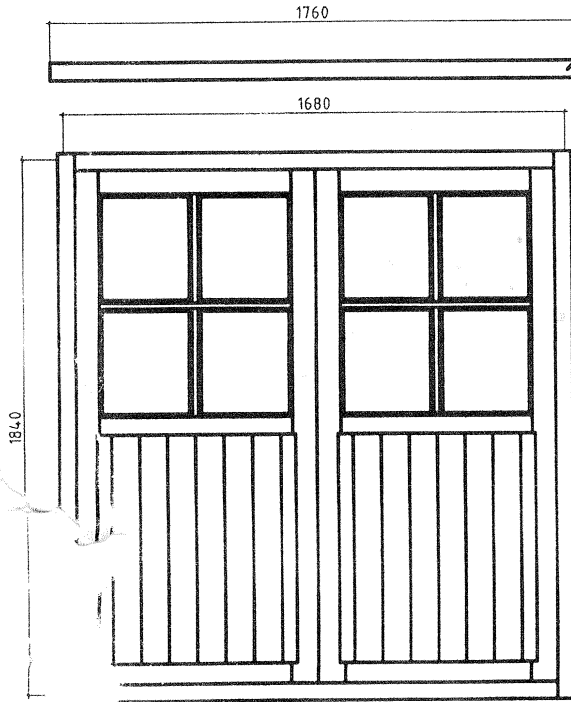

FLOORBEAMS

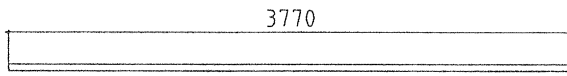

PT1 /5
90x45

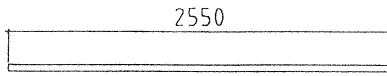





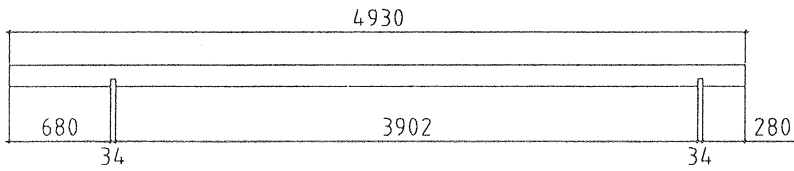

PT2 /2
90x45

PURLINS

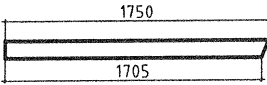

PR1 /3
45x145(45x95)

	FLOORBOARD 19x...	2500 mm	covers 3.91m
	ROOFBOARD 19x...	1700 mm	covers 2x4.93m
	SLAT 20x40	13 m.l.	
	GABLE BOARD 19x120	1750mm 4pcs	
	EAVE BOARD 19x120	4930mm 2pcs	
	EAVE SLAT 30x40	2465mm 4pcs	
	BOARD MATCHING WITH GABLE BOARD 19x90	1750mm 4pcs	
	BOARD ...x65 FOR SETTLEMENT SLOT	1760mm 2pcs	
Kood Triin D	Materjal	File Triin D.dwg	Leht 4/5

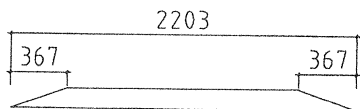

009 / 2

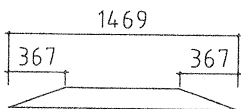

010 / 2

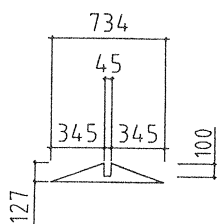

011 / 2

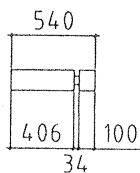

012 / 26

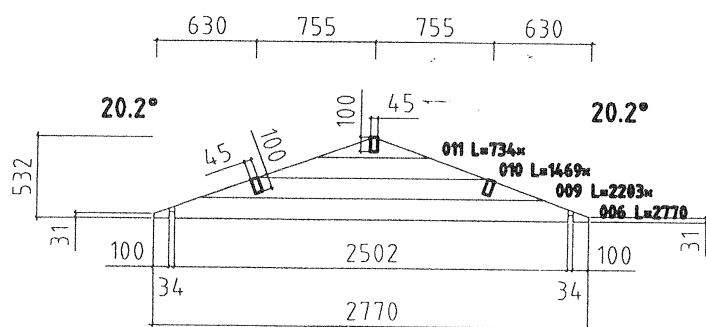

W1-1

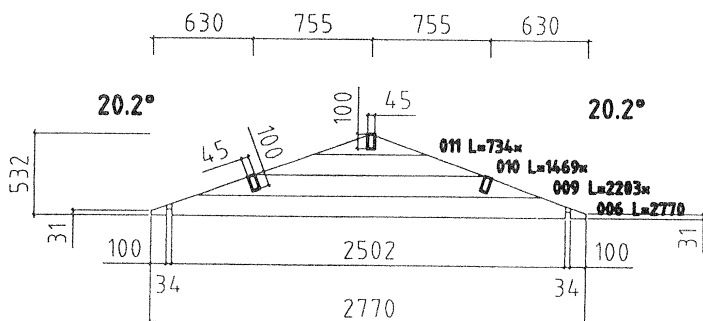

W2-1

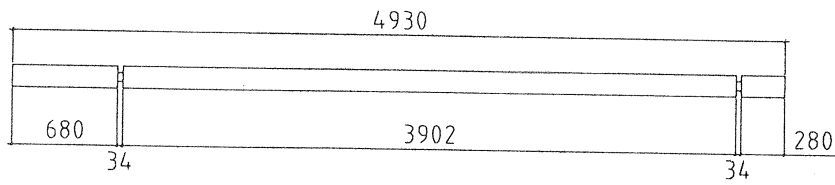

001 / 2

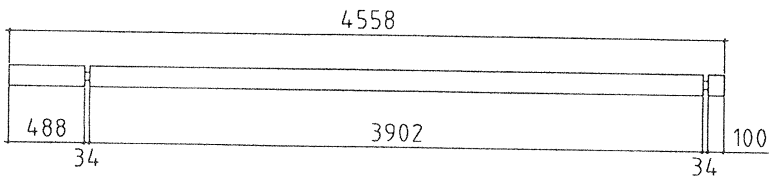

002 / 2

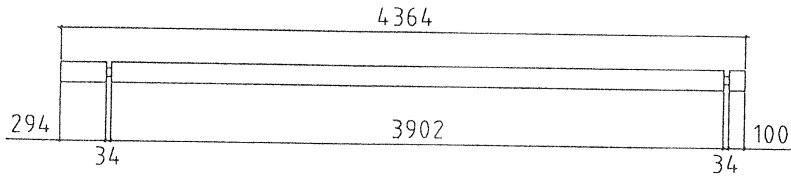

003 / 2

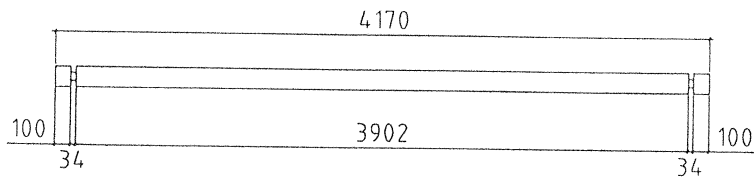

004 / 24

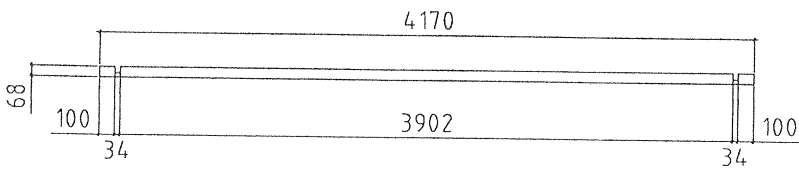

005 / 2

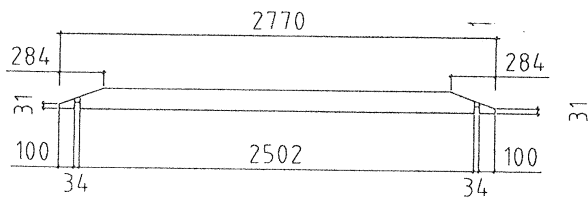

006 / 2

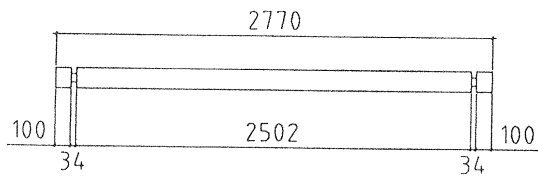

007 / 16

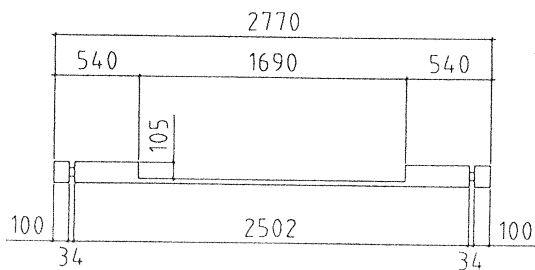

008 / 1

493

68

28

001

002

003

004

004

004

004

004

004

004

004

004

004

004

004

005

209,3

Wall B ↑

390,2

393,6

417

110,1

3,4

①

110,1

3,4

②

Kood	Triin D	Leht	3
Joonis	Wall B	Mootkava	1:25
Materjal	3.4x13.5	Kuup.	28.04.2008
Joonestaj	K.Kahu	File	Triin D.dwg

4.93

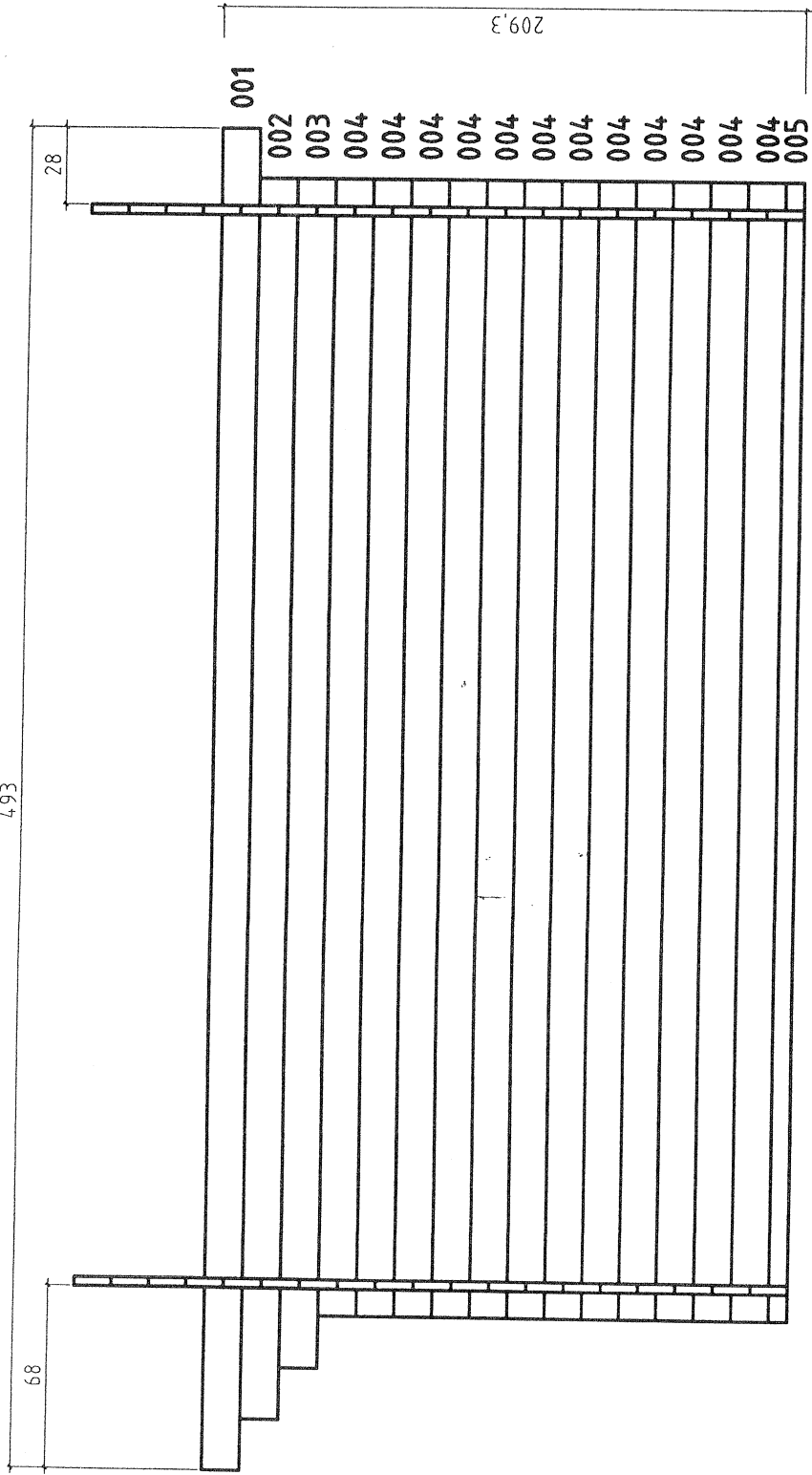

Wall A ↑

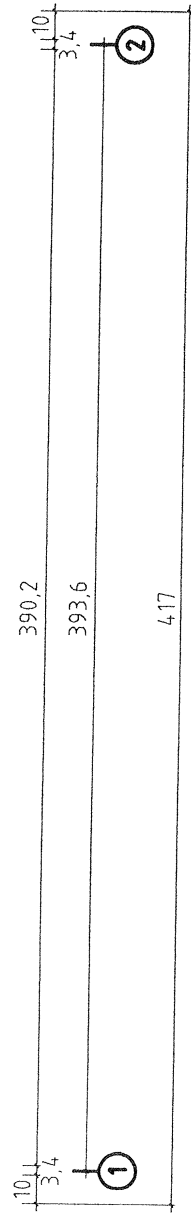

Kood	Triin D	Leht	2
Joonis	Wall A	Mootkava	1:25
Materjal	3.4x13.5	Kuup.	28.04.2008
Joonestras	K.Kahu	File	Triin D.dwg

NBI WALLBEAM ROUND THE HOUSE 10mm OVER THE EDGE

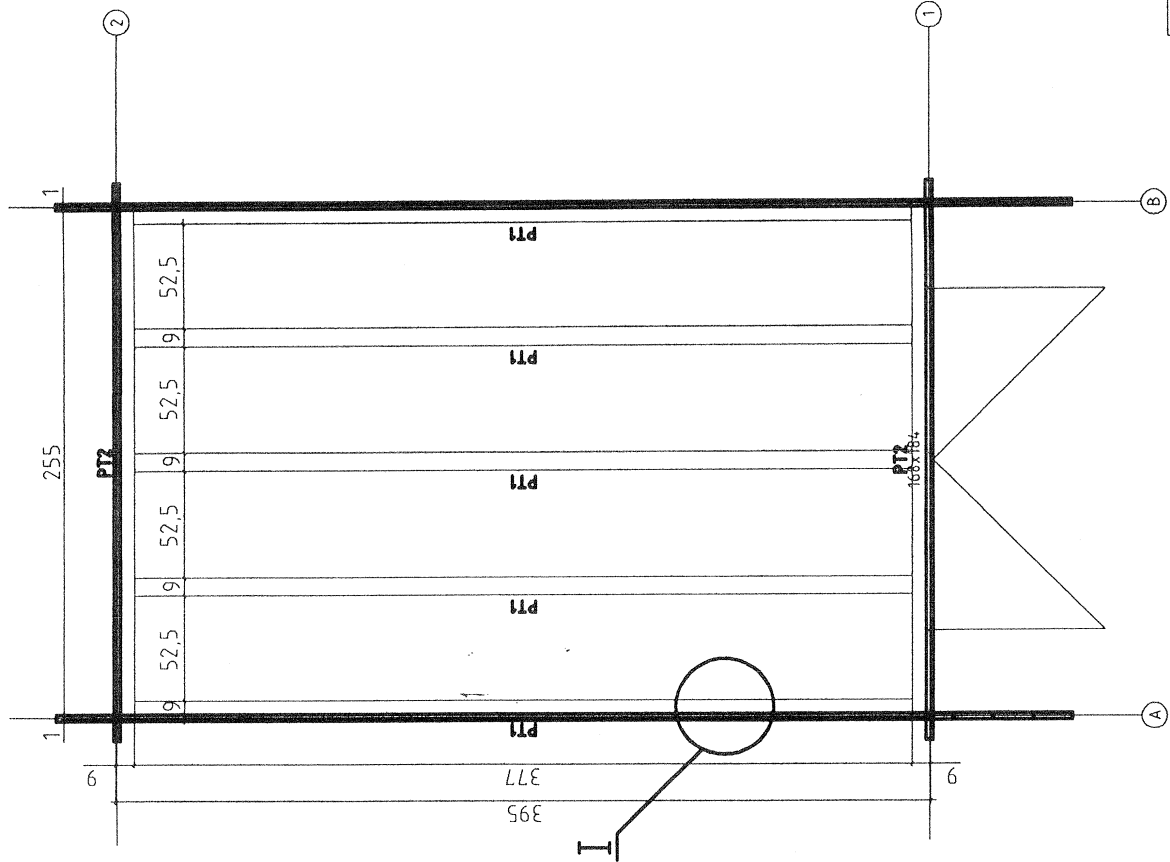
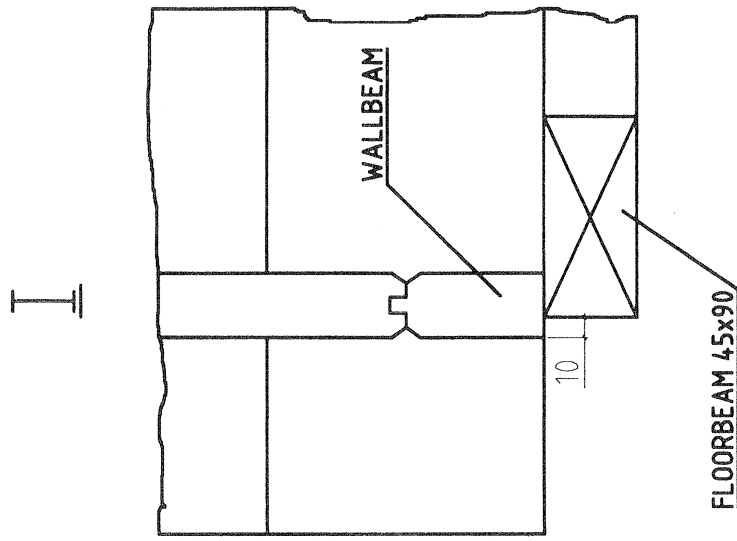

Room	Triin D	Leht	1
Joens	Floorbeams	Moottava	1:25
Materiaal	4,5x90	Kuop	28.04.2008
Joensitas	K.Kahu	File	Triin D floorbeams.dwg

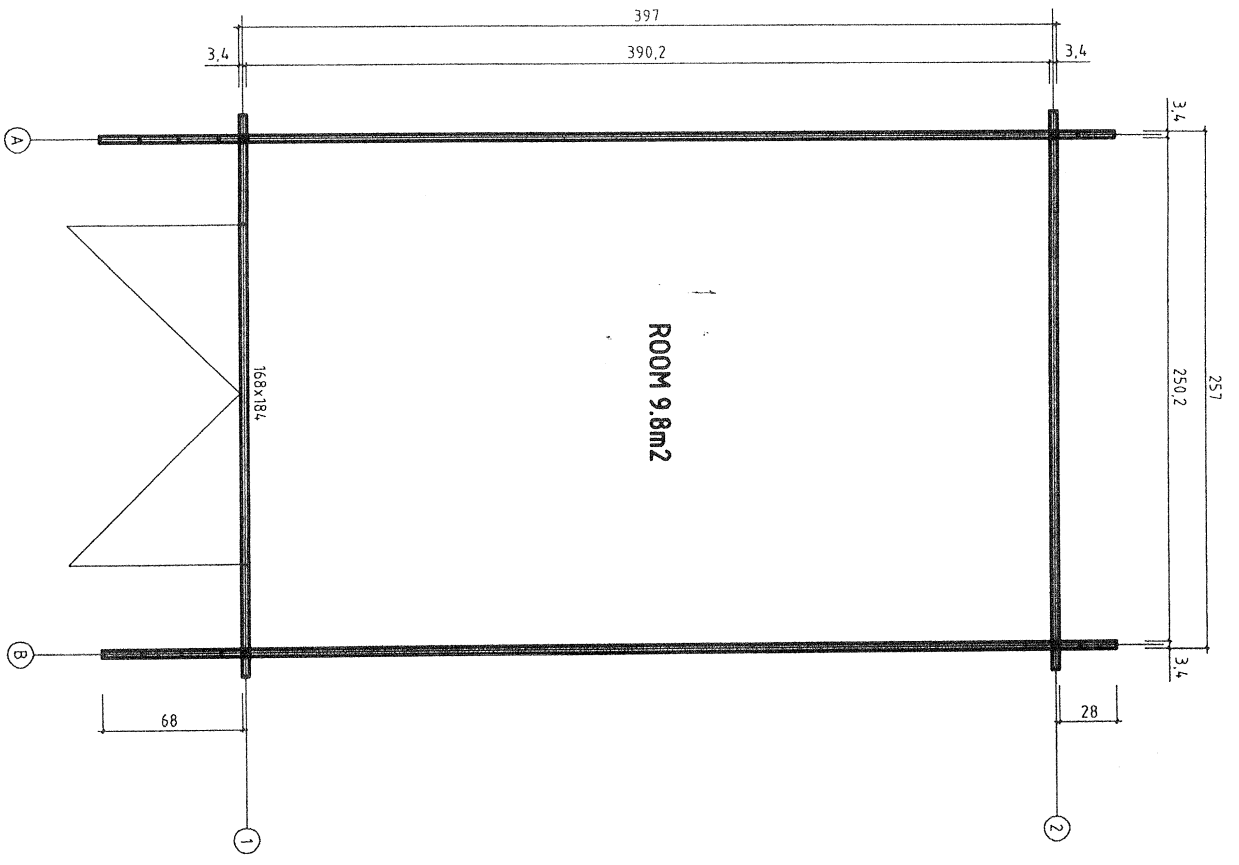

Kaed	Tiin D	Lem 1
Jenis	Plan	Hoolava 1:25
Material	34x135	Komp 28.04.2008
Joonedra	K Kahu	File Tiin D.dwg

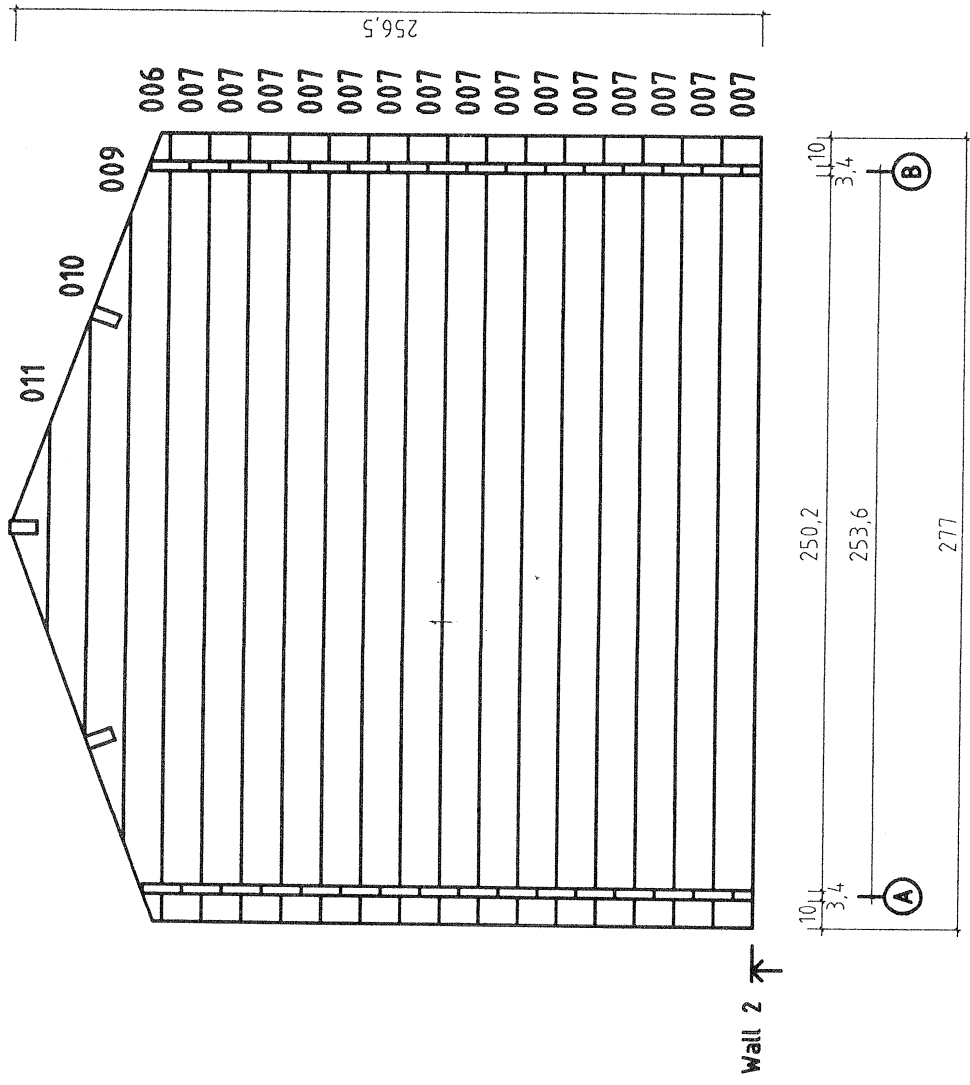

Kood	Triin D	Leht	5
Joonis	Wall 2	Mootkava	1:25
Materjal	3.4x13.5	Kuup	28.04.2008
Joonistas	K.Kahu	File	Triin D.dwg