

MOTTAKID
29. 7. 12
Dýnguneyri, V. Arnarhaga og Pósth.

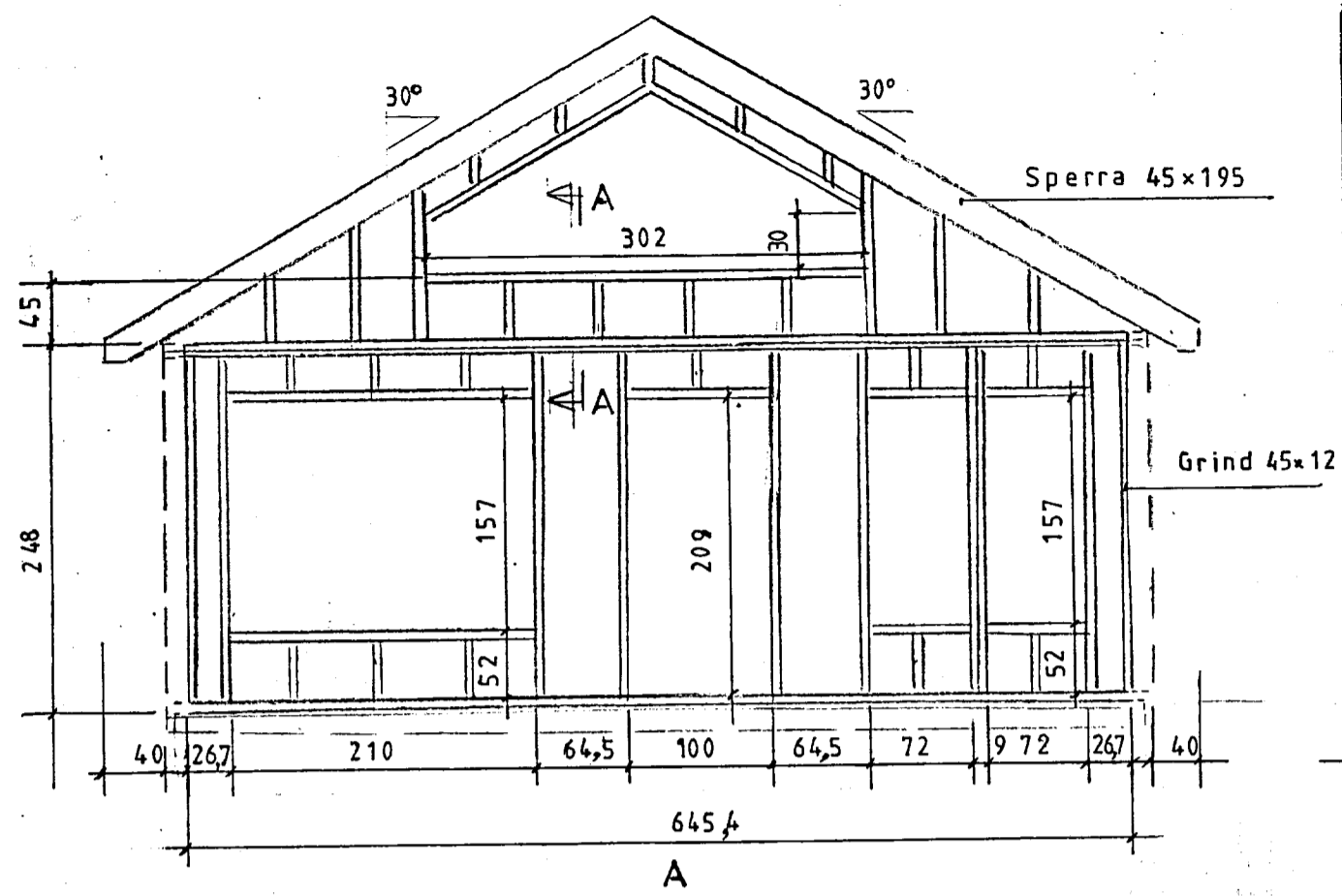

A

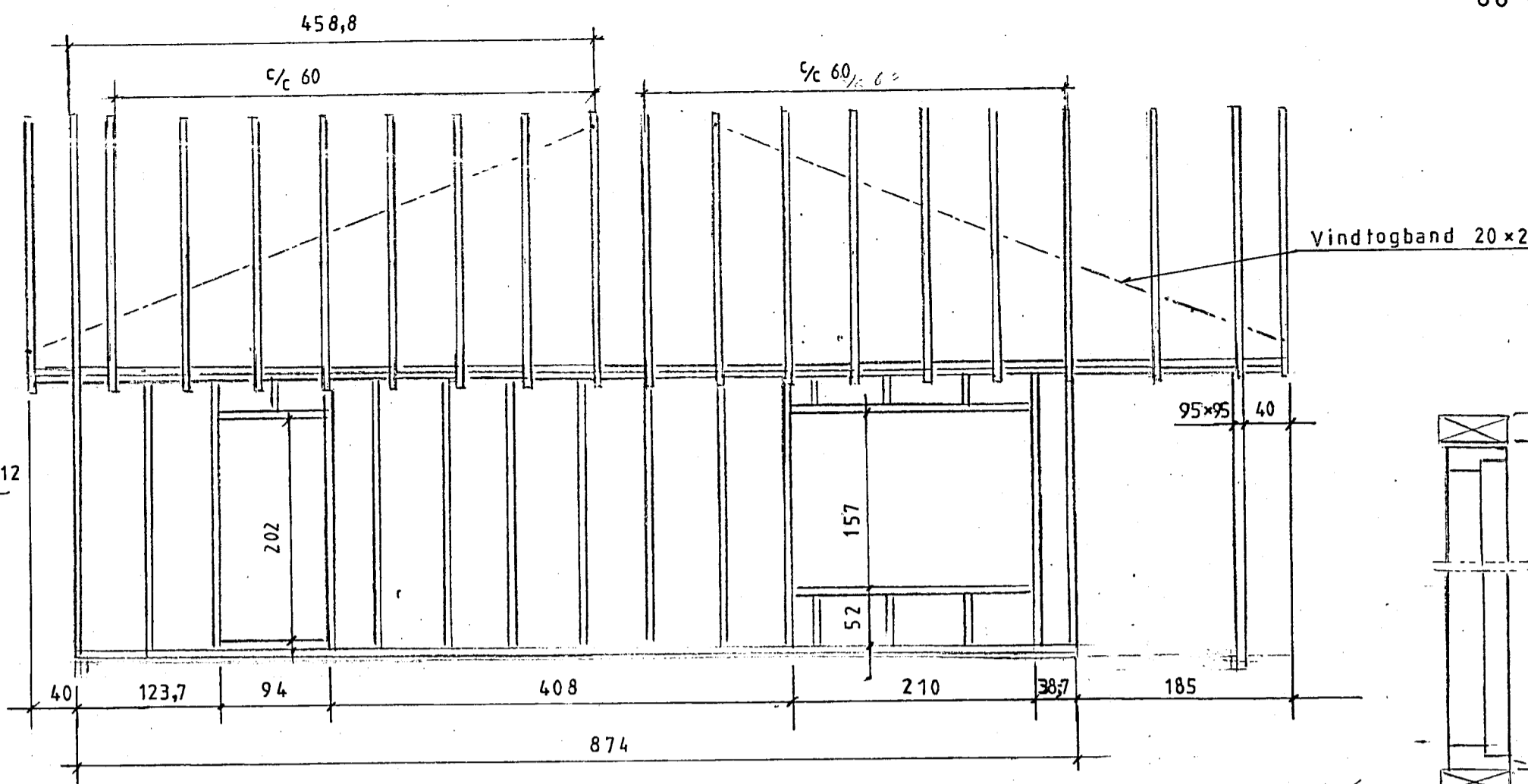

B

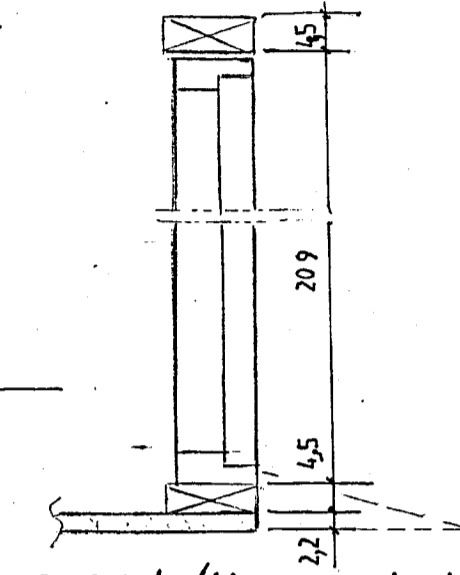

Snid í úti og svarhurð

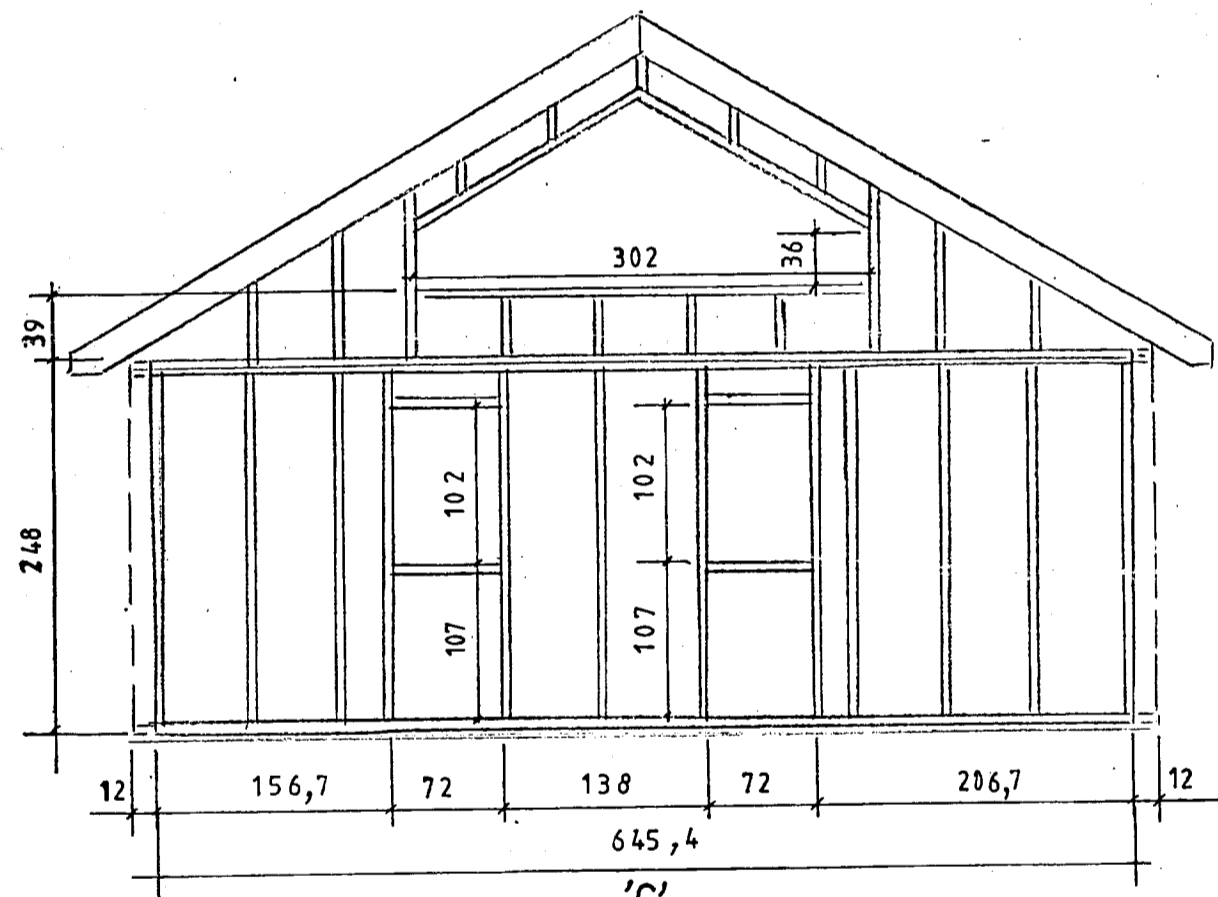

C

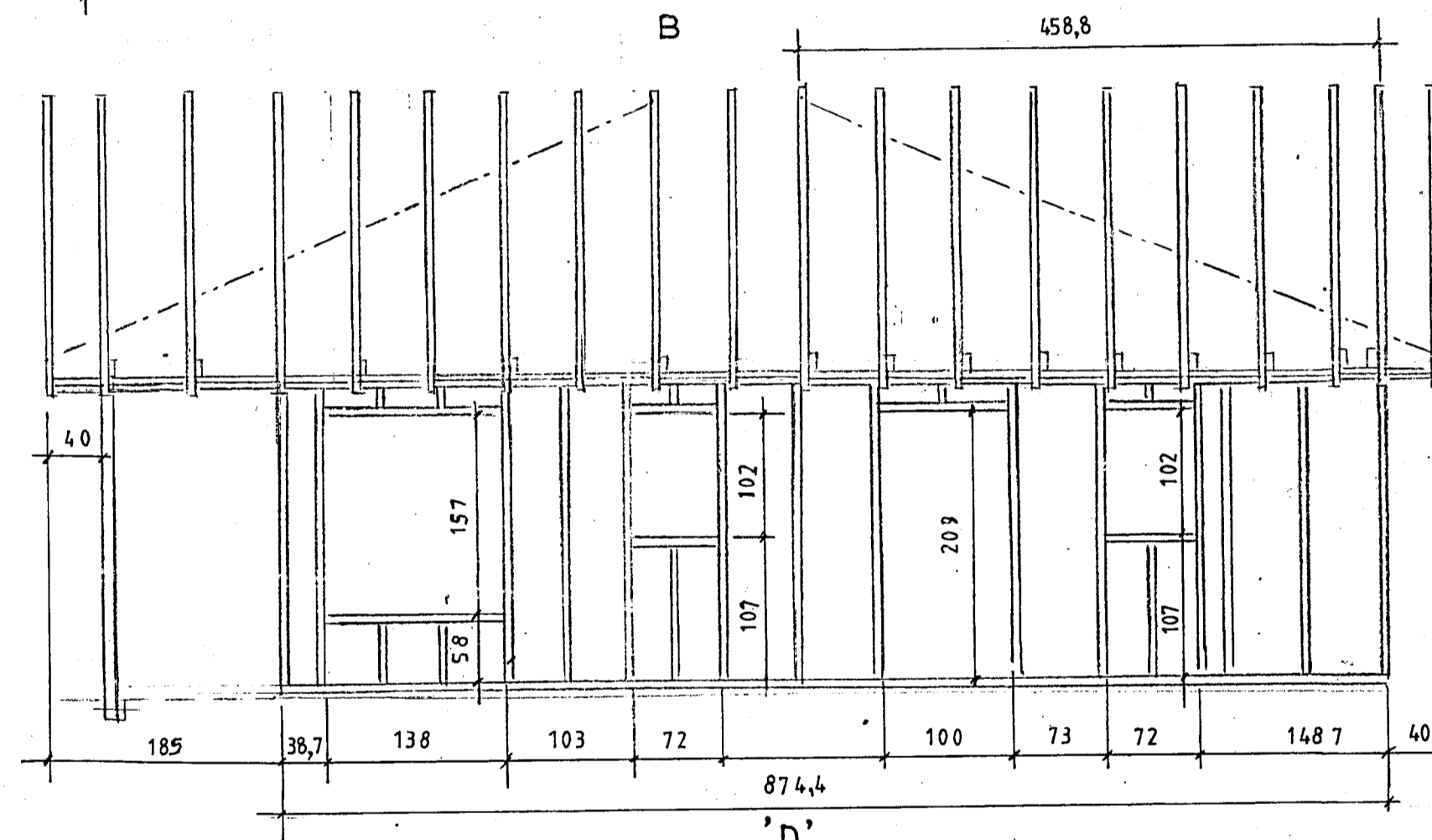

D

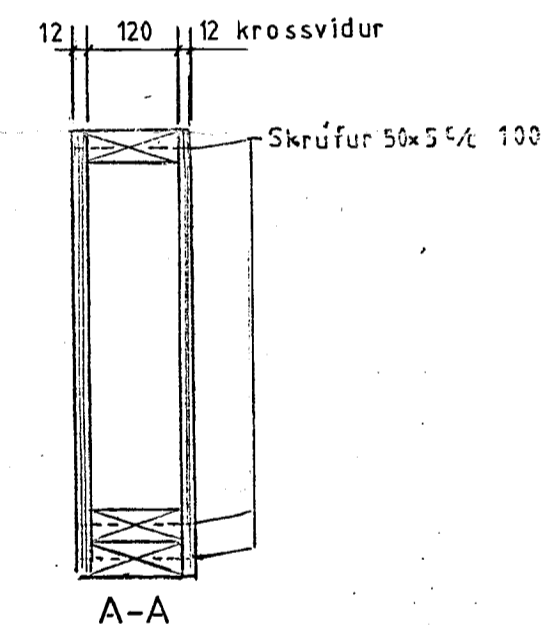

A-A

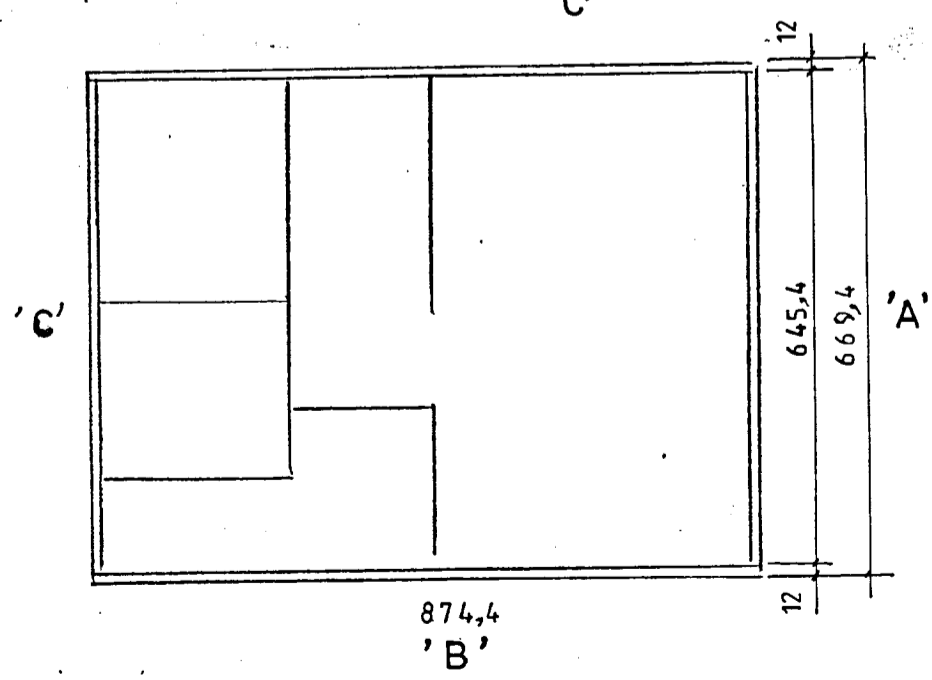

B

Ath.: Efni í grind og þakvidum, smíðaviður 4 fl T1

Mkv. 1:50, 1:10	Fristundarhús í landi Kerhrauns Grímsness og Grafningshr. Arnass. Lóð nr. 18 við Hraunsali, stæð 5789	TEIKNIVANGUR
Dags. sept. 12	Eigandi: Hafdis Sigurdardóttir kt. 060564-4269	<i>Hilgáimur Þórlákur</i> 270733-2559
Nr. 296-05	Grindur og þakv.	<i>Arísinn Þórgunnar</i> 201032-4829
	Burðarpólst.	