

Útlit – Norður
Mkv. 1:100

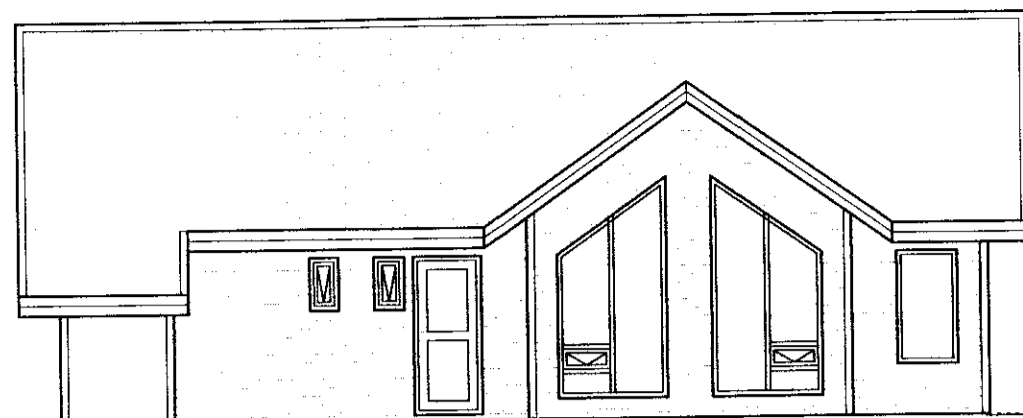

Útlit – Vestur
Mkv. 1:100

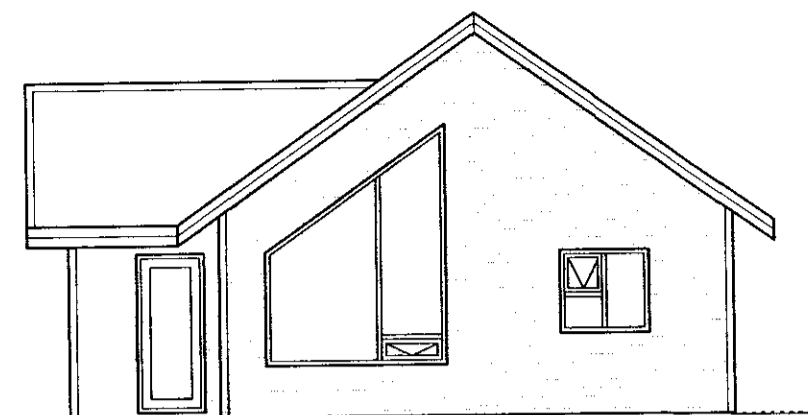

Útlit – Suður
Mkv. 1:100

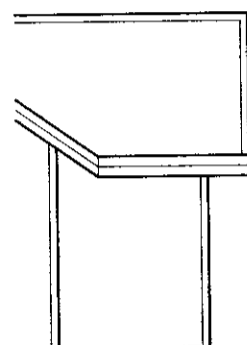

Útlit – Norður
Mkv. 1:100

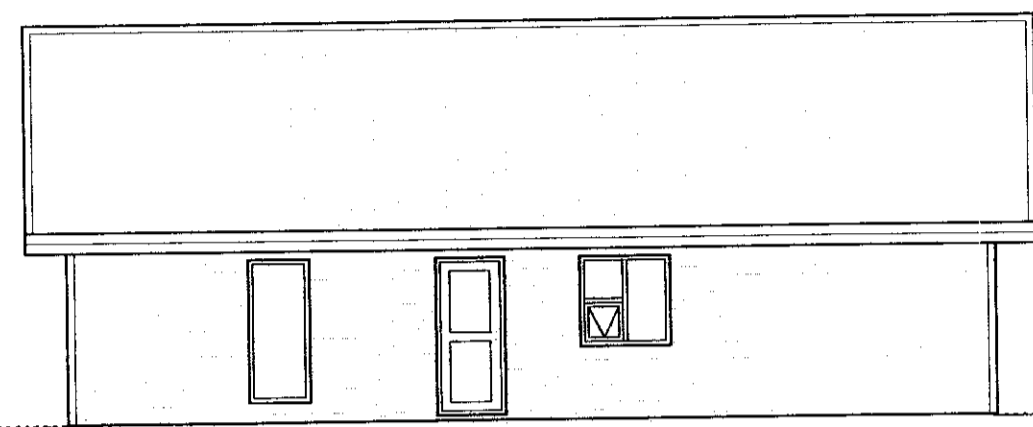

Útlit – Austur
Mkv. 1:100

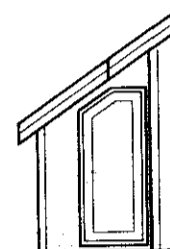

Útlit – Suður
Mkv. 1:100

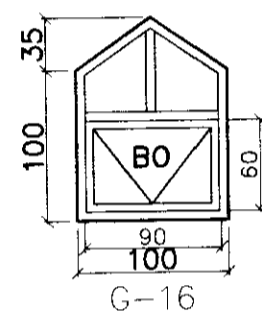

G-16

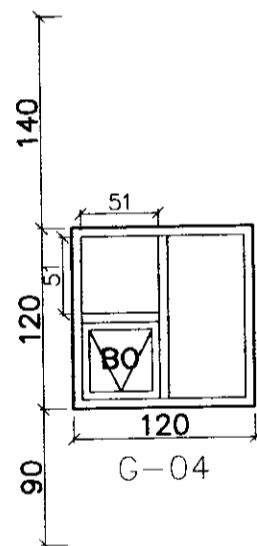

G-04

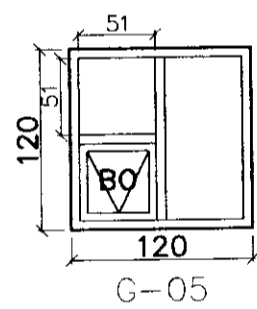

G-05

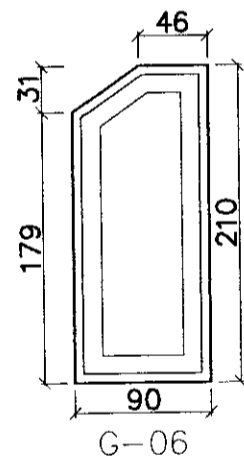

G-06

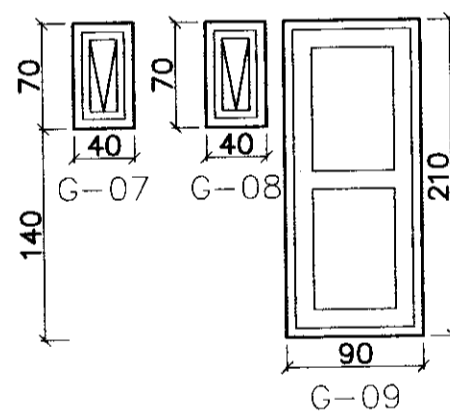

G-07

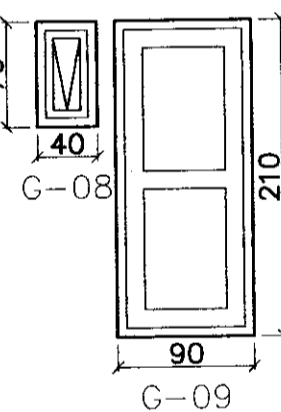

G-08

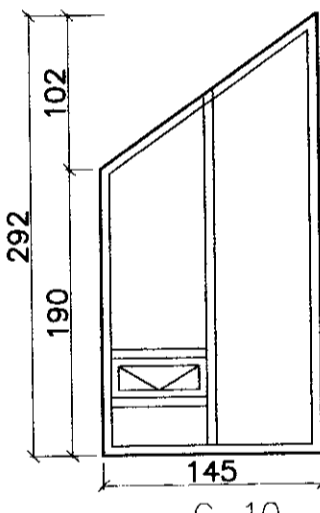

G-09

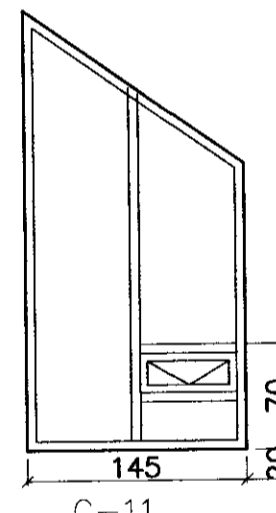

G-10

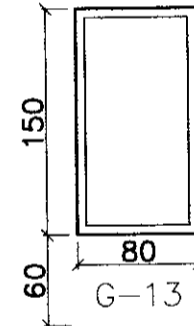

G-11

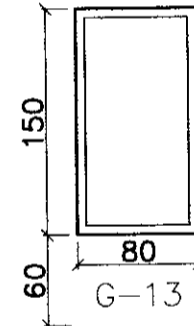

G-13

Gluggar & hurðir
Mkv. 1:50

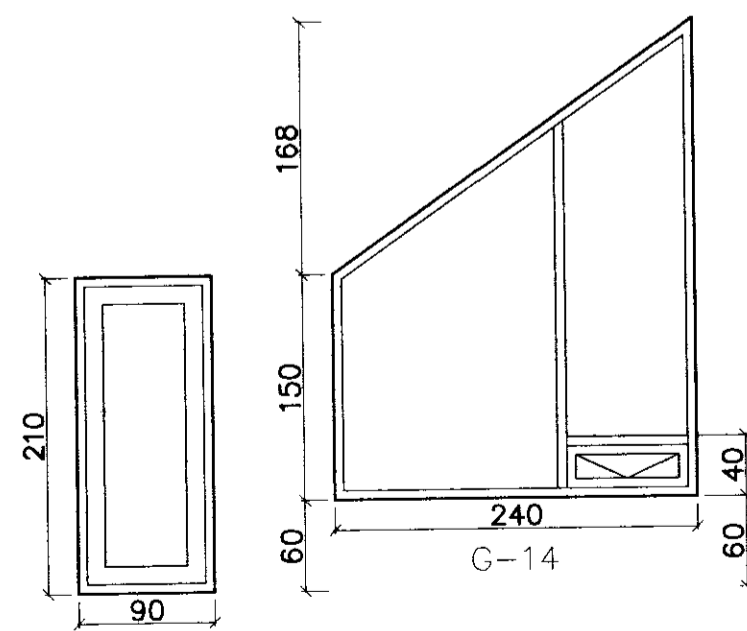

G-12

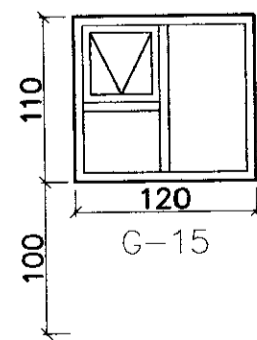

G-15

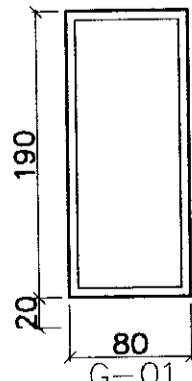

G-01

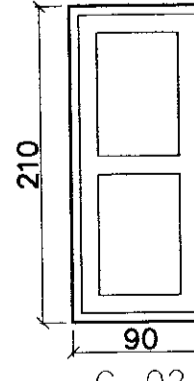

G-02

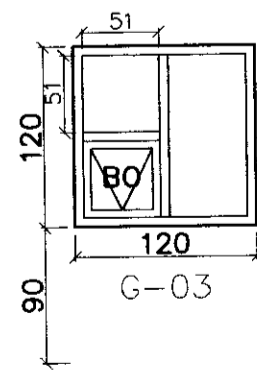

G-03

Gluggar & hurðir
Mkv. 1:50

SAMÞYKKT 06 APR 2011 <i>Ólafur Guðmundsson</i> Eyðingamynd, Matvæðing, Græssýslu og Flóahætt.			
DAGS:	NR:	BREYTINGAR:	SAMB.:

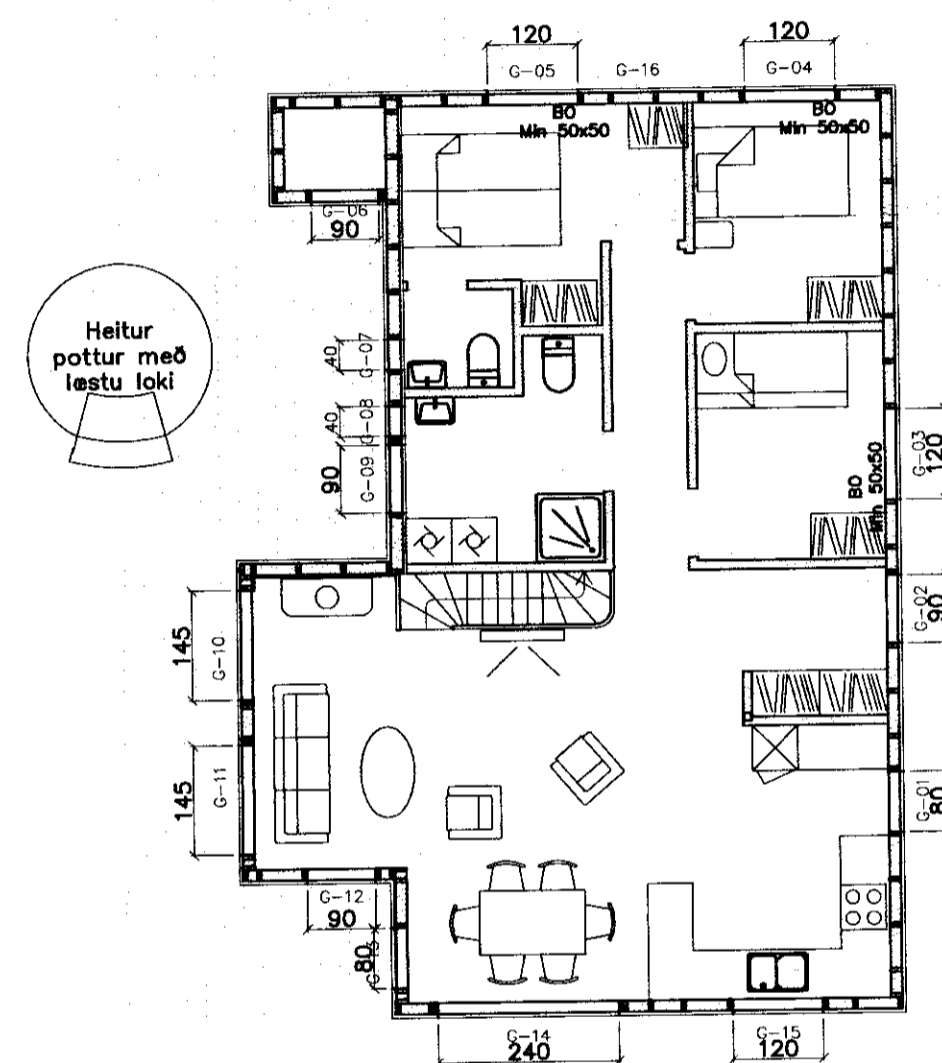

Grunnmynd – Gluggar
Mkv. 1:100

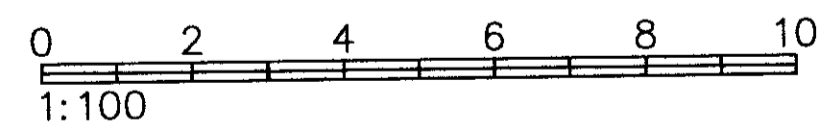

SKEIFAN 19 · 108 REYKJAVÍK · Sími: 517 9050 · Netfang: teknik@teknik.is		DAGS: 04.04.2011	
Hrauntröð 25 Grímsnes- og Grafingshreppur		Hönnuðir: Jón Guðmundsson 280255-4329 Guðmundur Hansson 151263-3649 Svavar M. Sigurjónsson 180867-3419	Dagslunnur: 101 Verkgæðir: 11-04
Þessi teikningar: Aðal- og brunavarnaruppdráttur Útlit Gluggar		Samþykkt: <i>Svavar M. Sigurjónsson</i>	Málfr.: 1:100/50
Hannaf.: SMS	Teiknari: SMS	Mált.:	Yfirsk.: 102

Q:\verkefni\11-17 Hrauntröð 25\Teikningar\A--tekn\101 Hrauntröð 25.dwg