

1 stk

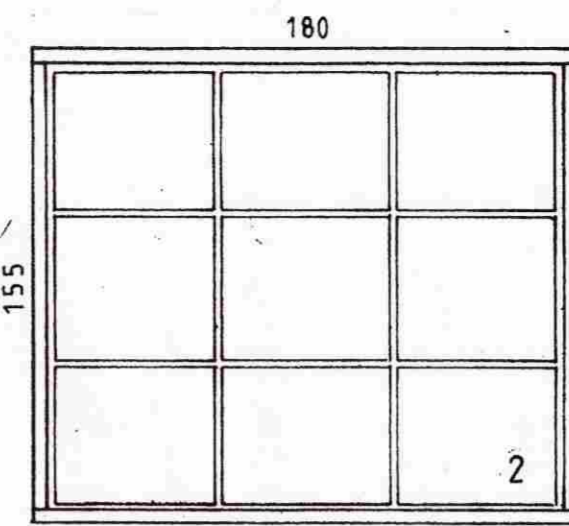

2 stk.

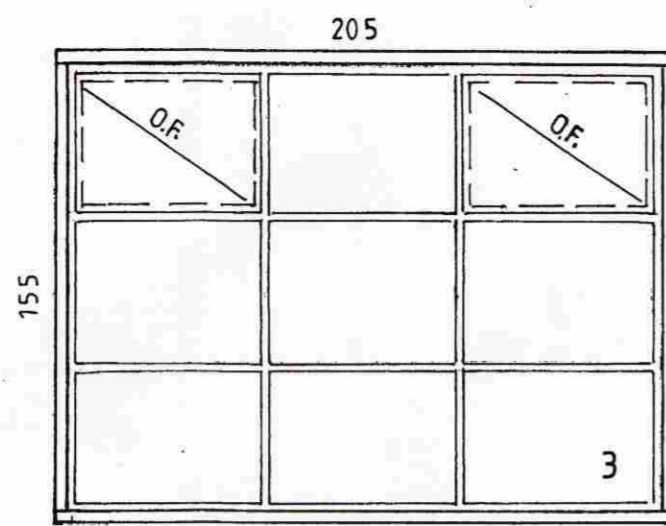

1 stk

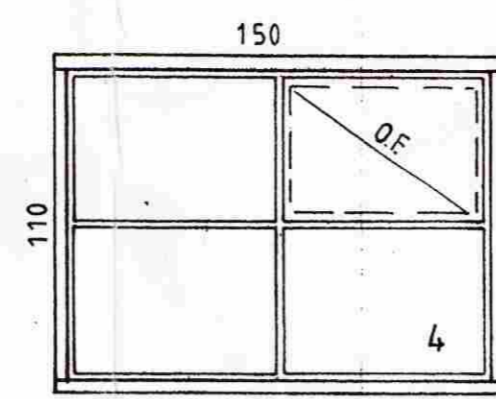

1 stk.

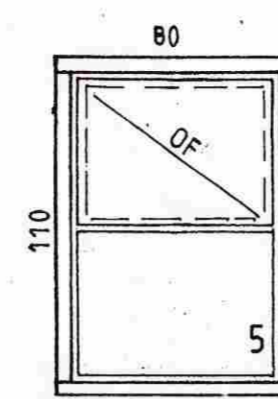

1 stk.

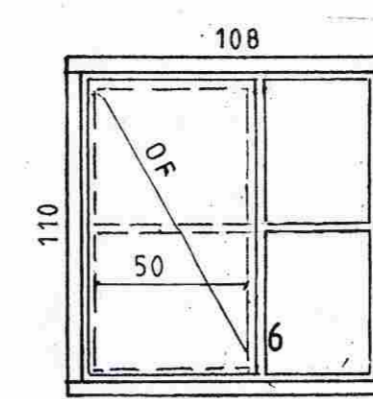

1 stk.

21-66

MÓTTEKID  
03. MARS 2009  
Byggingafultrúi uppsv. Árnassýslu og Flóahv.

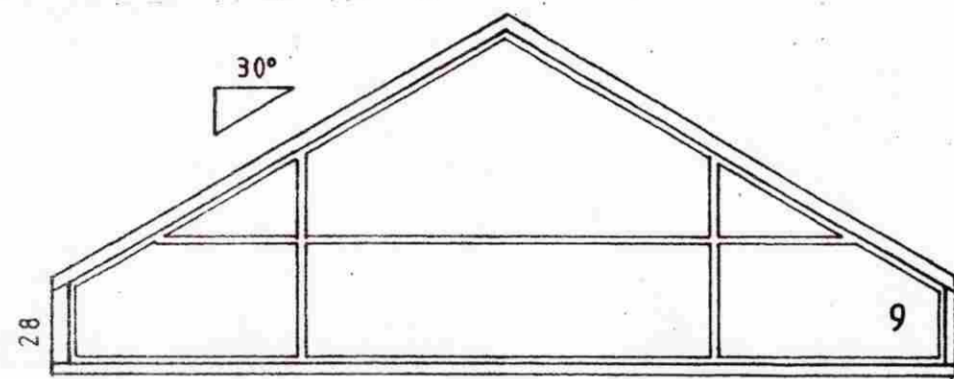

300  
1 stk.

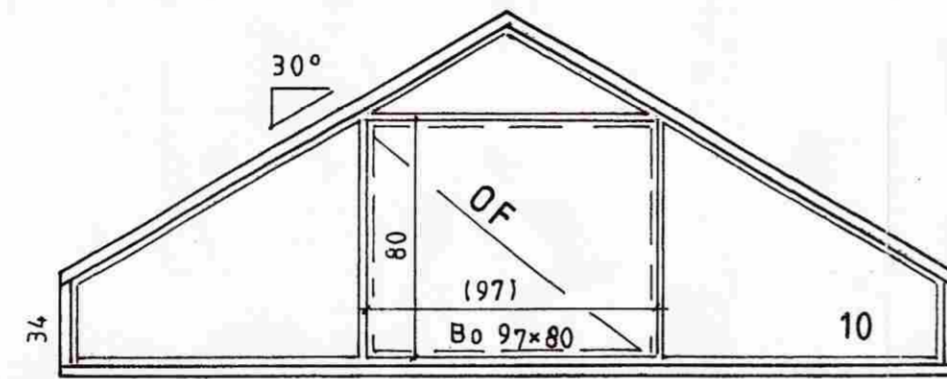

300  
1 stk

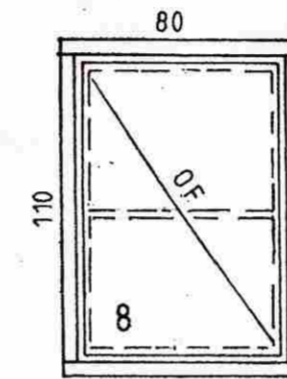

1 stk.

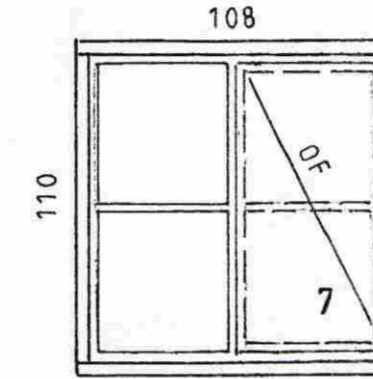

1 stk

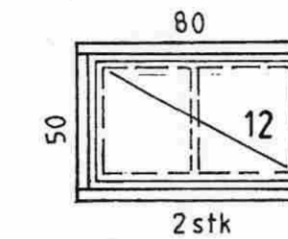

2 stk

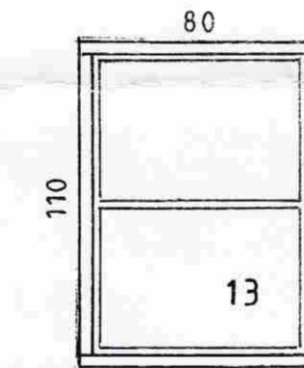

1 stk

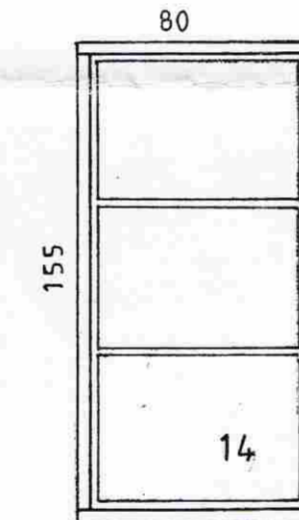

1 stk

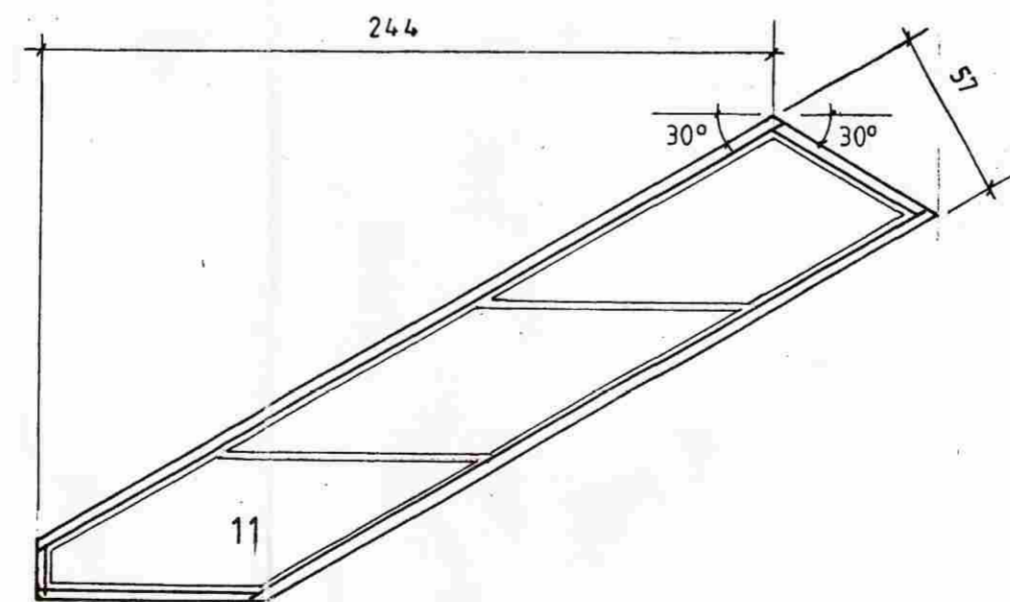
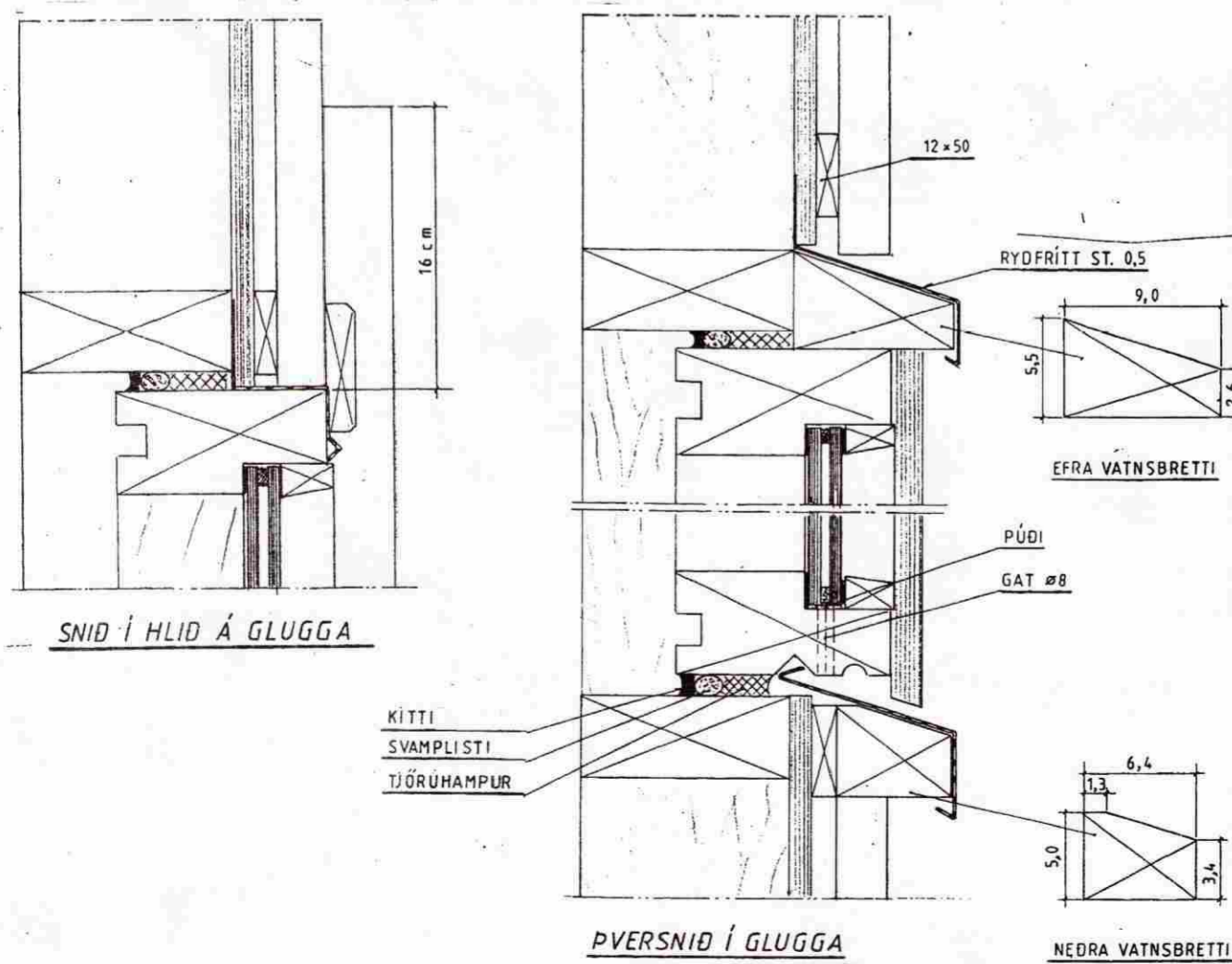

11

Mkv.: 1:25  
Dags. okt.'08  
Nr. 245-07

Sumarhús í landi, Snæfoksstaða Grímsness og Gráfnings-  
hreppi, Arnassýslu lóð nr. 103b stærð 5000 m<sup>2</sup>  
Eigandi: Jón Ingi Ingason kt.050753-5579  
Gluggar Deilimynd

TEIKNIVANGUR  
270733-2559  
201032-4829