

NORÐUR

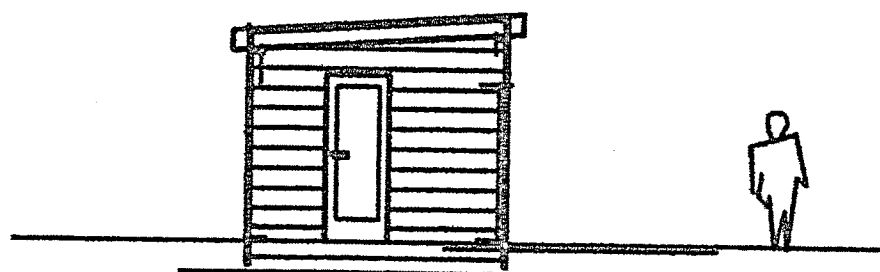

VESTUR

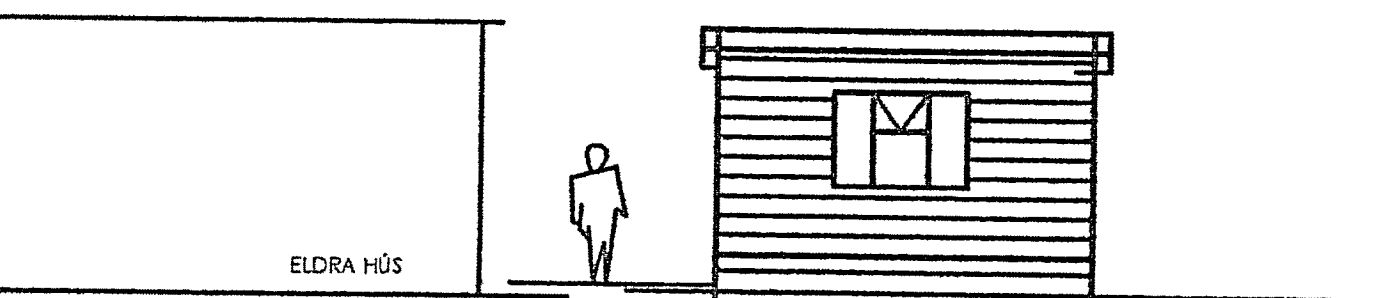

SUÐUR

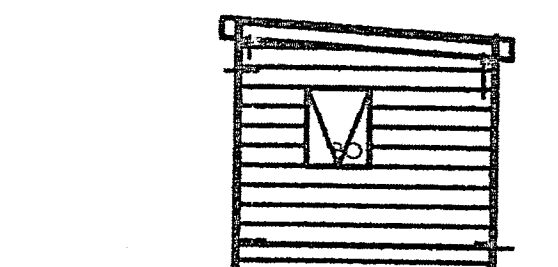

AUSTUR

- SKÝRINGAR:
- BO BJÖRGUNAROP
  - REYKSKYNJARAR
  - ST. SLÖKKVIÐÆKI
  - SA. SALERNI
  - LR LOFTRÆSING
  - GN GÓLFNIDURFALL
  - MÆLAGR. INNTAK F. VATN
  - R INNTAK F. RAFM.

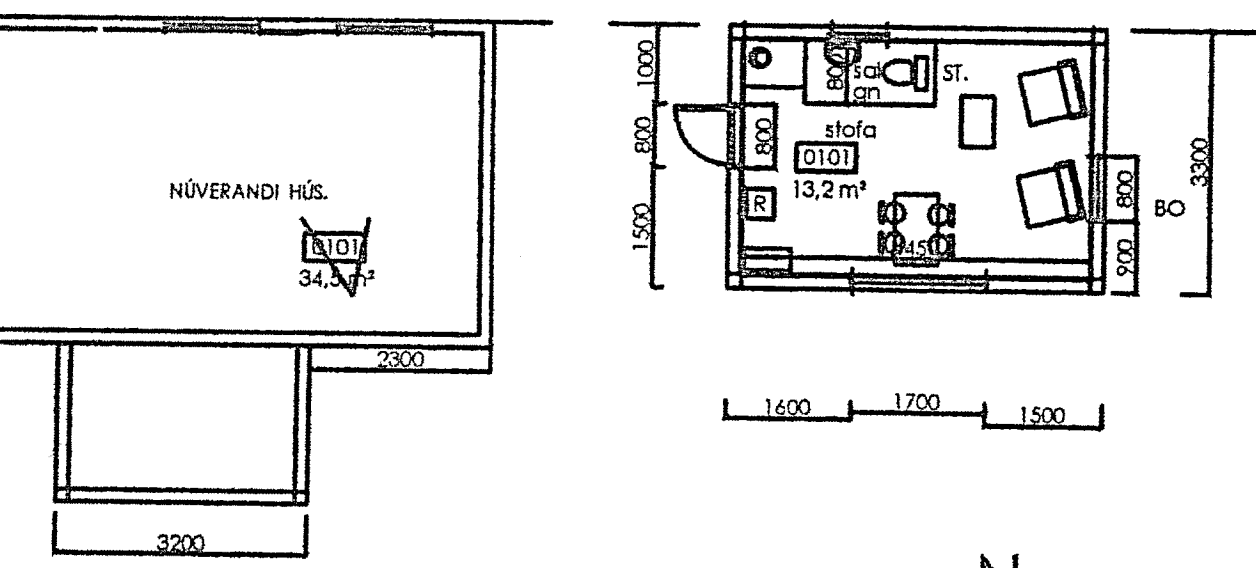
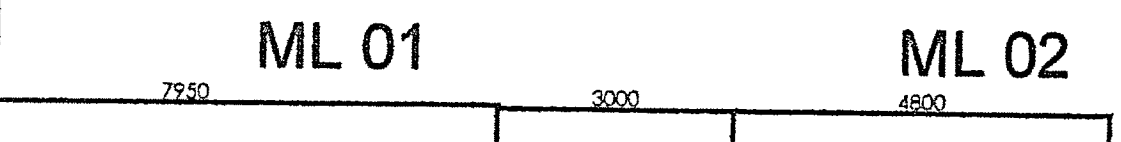

BR. Á STAÐSETNINGU.

GRUNNMYND

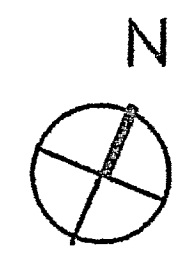

BÁRUJÁRN  
PAPPI  
SPERRUR 2" X 8" 50 X 200 MM C/C 600  
KLÆÐNING 1" X 6" 25 X 150 MM  
LOFTRÁS OFAN EINANGRUNAR, TVÖ Ø 32 MM, PR. SPERRUB.  
EINANGRUN, ÞÉTTULL 150 MM  
RAKASPERRA  
KLÆÐNING Í FL. 2

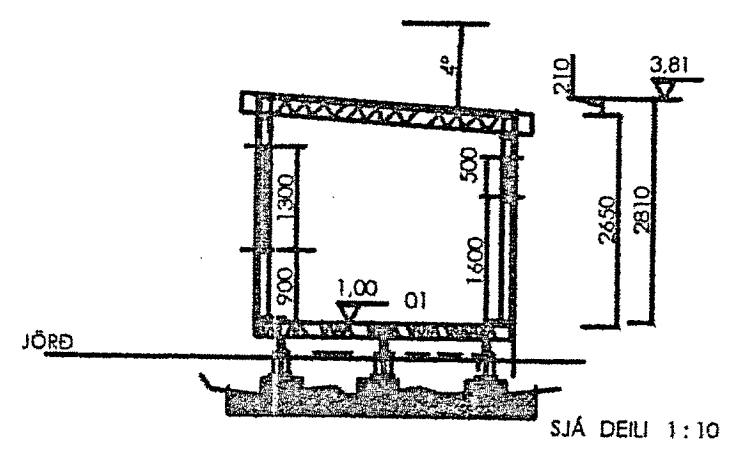

SNIÐ A-A

VEGGIR UNDIR DREGURUM 2K12 HRINGINN, (HVALLAR) ath...  
OFAN OG NEDAN  
AKKERI ÚR VEGG OG Í DREGARA og dregara í gólfbita...  
ERU Á BERANLEGGUM OG FROSTFRJUMJARDVEG  
AKKERI ÚR VEGG OG Í GÓLFBITA. BOLTADSAMAN

22 MM NÓTADAR SPÓNPL.  
RAKASPERRA  
GÓLFBITAR 2" X 6" 50 X 150 MM C/C 600  
EINANGRUN ÞÉTTULL 125 MM  
KROSSVIÐUR. 11 MM  
DREGARAR 3 STK. 50 X 200 mm

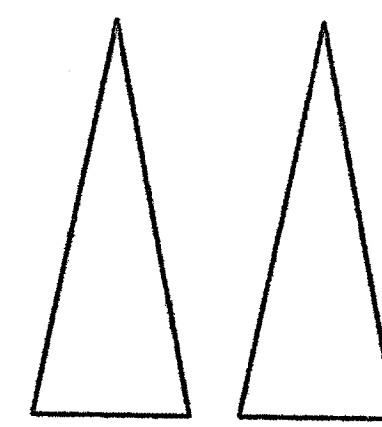

BÍLASTÆÐI

F = 1 826,0 M<sup>2</sup>

ML 02

STÆRÐ HÚSS: 15,8 M<sup>2</sup>

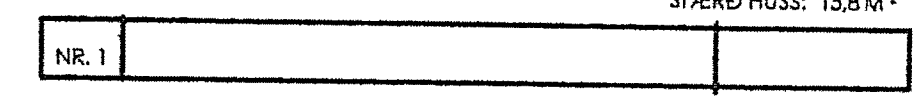

**SUMARHÚS.**  
HVANNALUNDUR NR. 1.  
ÞINGVALLAHR. GRÍMSNES „GRAFNING.

• LR. 170438 ST. 5 3540 0010  
HVANNALUNDUR NR. 1. ÞINGV. TEIKN. A2  
DAGS: 27.05.2013 GRUNNMYND, ÚTLIT OG SNIÐ 1:100  
artik@simnet.is GSM 895 - 9202  
ARTIK TEIKNISTOFA SÍMI 421 - 4122

STEINAR H. GERDAL BYGGINGAFRÆÐINGUR B.F.I.  
040138 3829 DRANGAVELLIR NR. 2, 230 KEFLAVÍK

AA02