

MÖTTEKIÐ
27. DES. 2012
Byggingulmál og Framfarir

UNDIRRITUN SAMRÆMINGARHÖNNUNAR

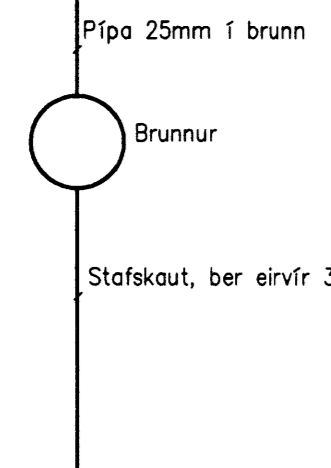

FRÁGANBUR Á SAMTENGINGUM STEYPUENA FYRIR SÖKKULJARDSKAUT

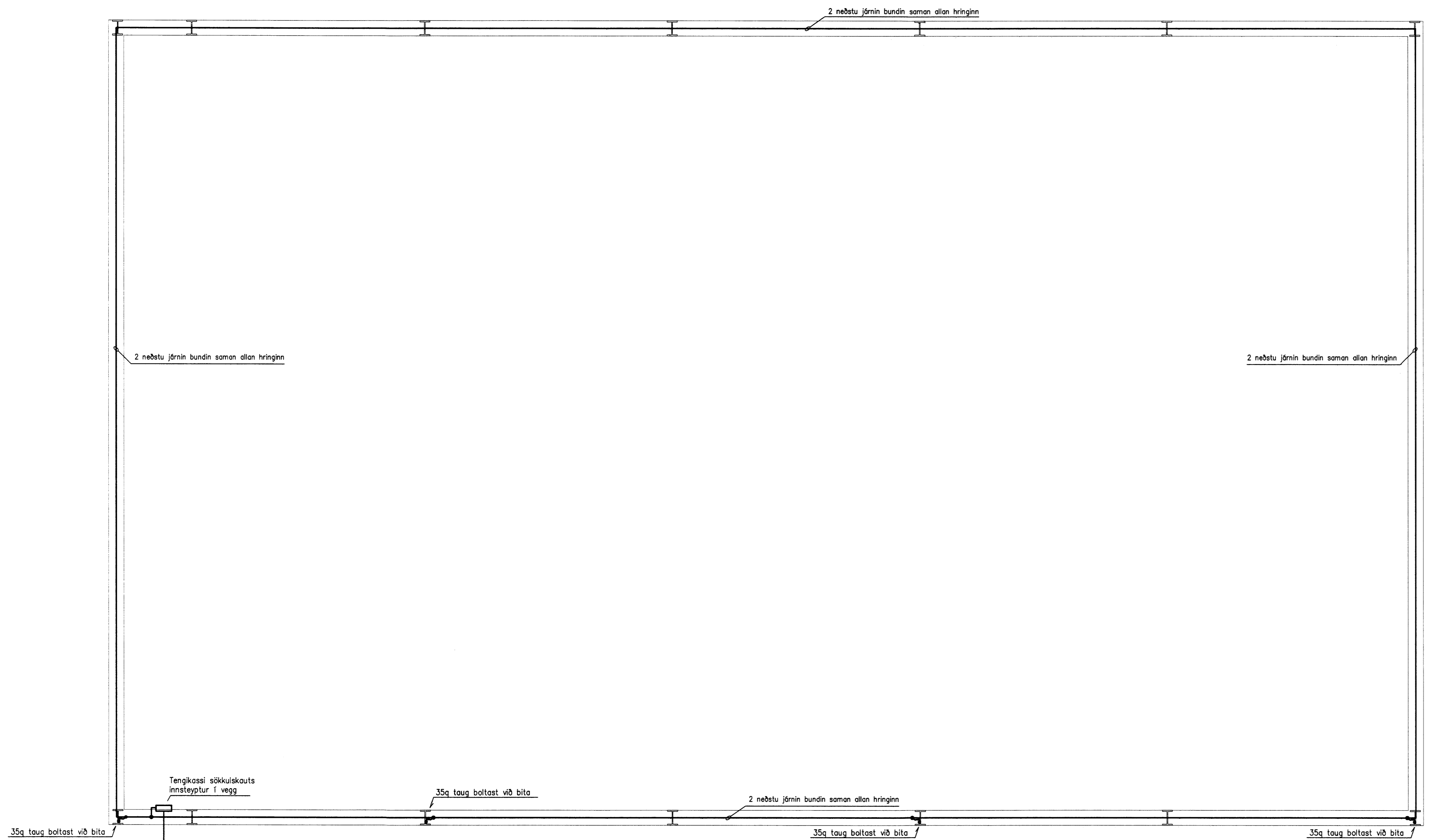
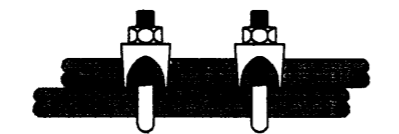

SNID Í STEYPUMÓT

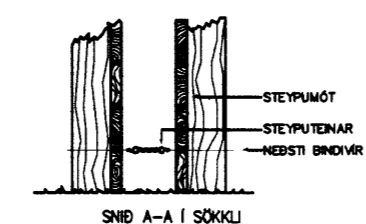

SAMTENGING STEYPUENA SETJA SKAL TVO VIRALASA Á HVERT SAMSKETTI

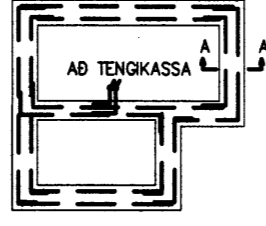

Sökkulskaut, damigerður frágangur við sökkulskaut, myndir ekki í málkvörðu

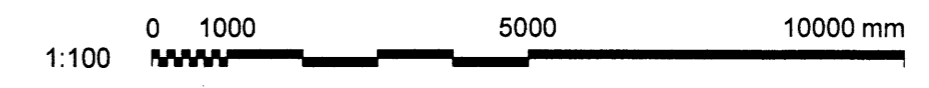
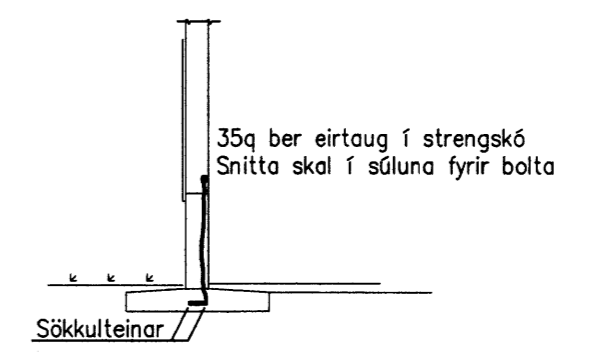
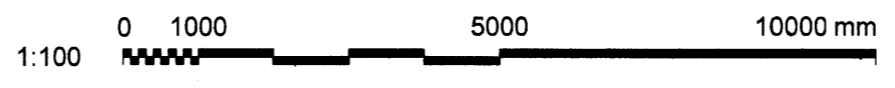
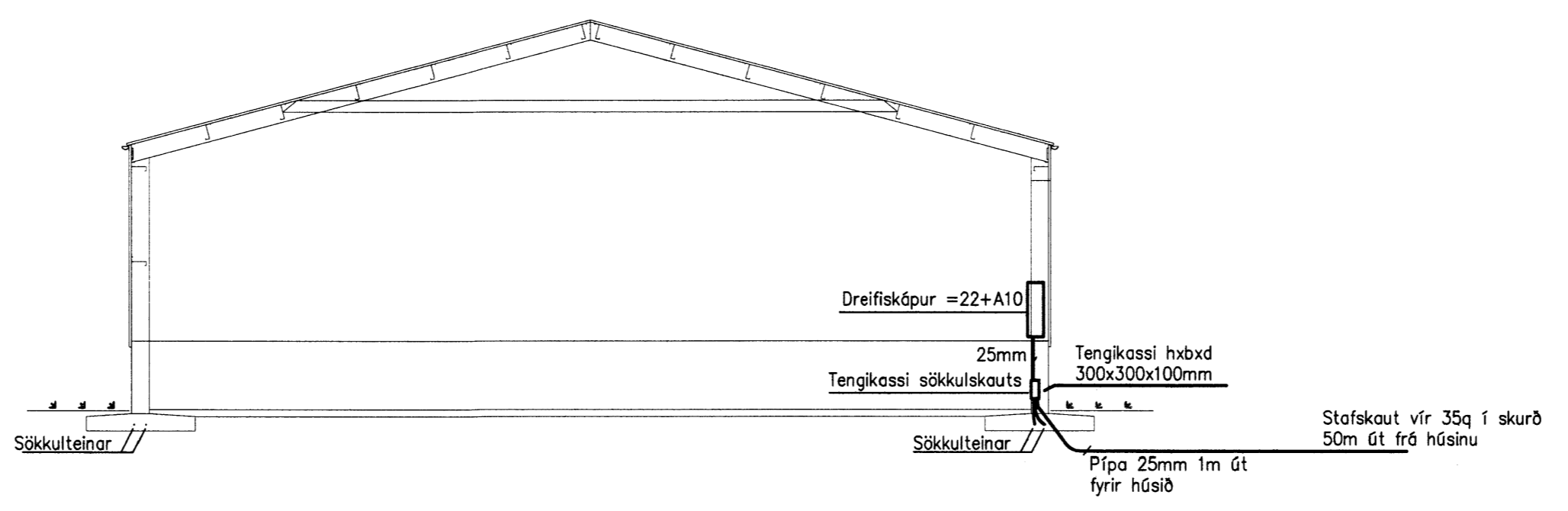

Frumstærð blaðs A1



www.verkis.is - sími: +354 422 8000

SAMPYKKT: *Björn Þór*

A 2012-08-27 VINNUTEIKNING BPS BPS ÞOG BPS

ÚTG DAGS SKÝRINGAR TEIK HANN RYNT SAMÞ

MIKLAHOLT, BLÁSKÓGARBYGGÐ
KORNHLAÐA
Sökkulskautskerfi
Grunnmynd sökuls

VERKFANG 12169 TEIKNING E05.5.101 A